

# HAMMER<sub>RIGID</sub>

ORDER FORM 2023

Tel: 951-808-9131 FAX: 951-808-9949  
Toll Free: 800-892-8998 www.colourswheelchair.com

DEALER		COLOURS INFORMATION For Office Use Only	
Dealer:		Order Date:	S/N:
Account:	P.O.#:		
Ordered By:			
Customer Name:			
Customer Weight:			
CHAIR INFORMATION		PRICE	
<b>HAMMER</b> <b>Fixed FSH-RSH</b> <b>Max. Capacity 250Lbs</b>		Base Wheel Chair Price \$ 3,100	
NOTE		Total Section A \$	
<b>Main Frame : ZK55 &amp; ZK60 High Grade A7000 Series Aluminum</b> *For contact sports, No warranty applies.		Total Section B \$	
		Total Section C(Custom Parts Color) \$	
		Total Section D \$	
		Total Section E \$	
		Total Section F \$	
		ORDER GRAND TOTAL \$	

## A FRAME COLORS & PARTS COLORS

FRAME COLORS		
<b>Powder-Co</b> <input type="checkbox"/> Gloss Black <input type="checkbox"/> Twilight Flake <input type="checkbox"/> Yellow <input type="checkbox"/> Magenta <input type="checkbox"/> Fire Engine Red <input type="checkbox"/> White		
<input type="checkbox"/> Neon Yellow <input type="checkbox"/> Candy Blue <input type="checkbox"/> Candy Purple <input type="checkbox"/> Candy Green <input type="checkbox"/> Candy Red <input type="checkbox"/> Candy Raspberry <input type="checkbox"/> Cobalt Blue		
<input type="checkbox"/> Brass Metallic <input type="checkbox"/> Matte Gray <input type="checkbox"/> Matte Purple <input type="checkbox"/> Matte Blue <input type="checkbox"/> Matte Green <input type="checkbox"/> Matte Black <input type="checkbox"/> Matte Red		
<input type="checkbox"/> Tiffany Blue <input type="checkbox"/> Blue Lilac <input type="checkbox"/> Neon Green <input type="checkbox"/> Orange Sparkle <input type="checkbox"/> Mellon Yellow <input type="checkbox"/> Gun Smoke Silver <input type="checkbox"/> Shocker Yellow		
<input type="checkbox"/> Sparkle Burgundy <input type="checkbox"/> Granny Sparkle Green <input type="checkbox"/> Sparkle Sky Blue <input type="checkbox"/> Reed Green		STD
<b>Special</b> <input type="checkbox"/> Polished ..... <input type="checkbox"/> 24 karat Gold Plated .....		\$ 920 \$ CFP
PARTS COLORS ( Custom Parts Color Section, Please see Section C)		
<b>STD Color</b> Black Color (*Suspension Springs-Silver Color Only)-		\$ STD
<b>Custom Color Main Bolt on Parts One Color Package</b>	<input type="checkbox"/> Powder-Coated ( ) <input type="checkbox"/> Polished ..... <input type="checkbox"/> 24 karat Gold Plated .....	\$ 450 \$ 633 \$ CFP
Including: Backrest, Foot Plate, Backrest Brackets, Saddle Stops, Forks, Caps, Camber Discs ☆marked parts		

**B** FRAME MEASUREMENTS 1/2

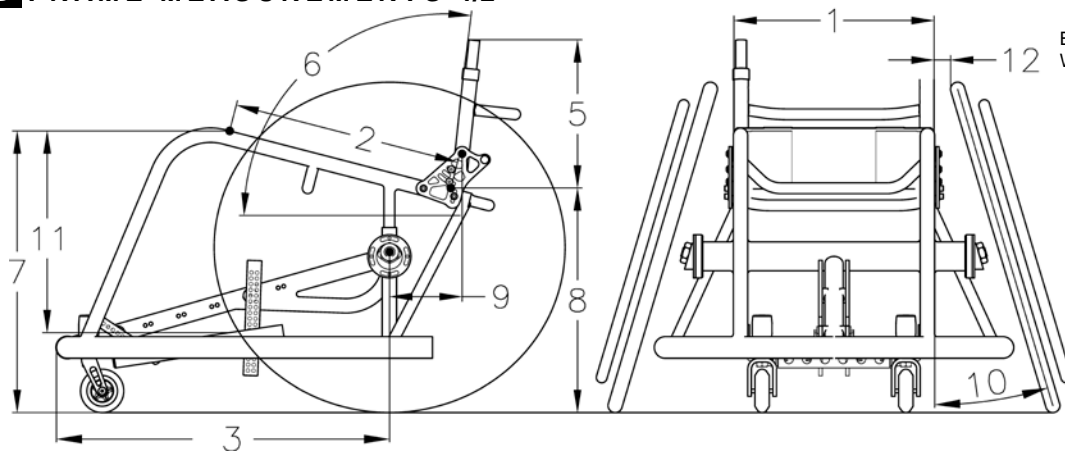

4. Wheelie Bar

Bolt on Single Wheelie Bar

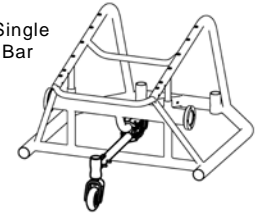

Dual Welded Wheelie Bars

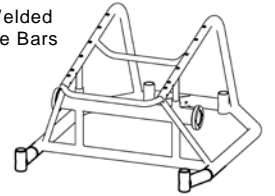

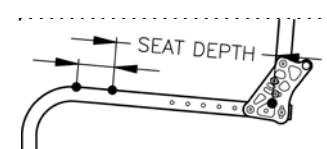
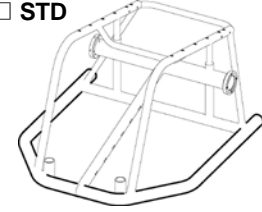
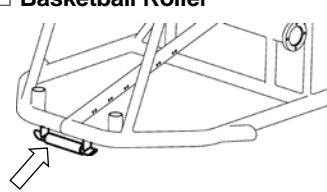
<b>1. SEAT WIDTH</b>	<input type="checkbox"/> 13" <input type="checkbox"/> 14" <input type="checkbox"/> 15" <input type="checkbox"/> 16" <input type="checkbox"/> 17" <input type="checkbox"/> 18" .....	\$ STD
	<input type="checkbox"/> 19" <input type="checkbox"/> 20" .....	\$ 345
<b>2. SEAT DEPTH</b>	<b>Net Seat Depth</b> <input type="checkbox"/> 13" <input type="checkbox"/> 14" <input type="checkbox"/> 15" <input type="checkbox"/> 16" <input type="checkbox"/> 17" <input type="checkbox"/> 18" <input type="checkbox"/> 19" .....	\$ STD
	<input type="checkbox"/> 20" .....	\$ 200
	<input type="checkbox"/> Aluminum Seat Pan	\$ 324
	<input type="checkbox"/> Positioning Frame   Add (   " ) .....	\$ 200
		
<b>3. FRAME LENGTH</b>	<input type="checkbox"/> 16" <input type="checkbox"/> 17" <input type="checkbox"/> 18" <input type="checkbox"/> 19" <input type="checkbox"/> 20" <input type="checkbox"/> 21" <input type="checkbox"/> 22" .....	\$ STD
	<input type="checkbox"/> Custom (   " ) .....	\$ 200
<b>4. WHEELIE BAR STYLE</b>	<input type="checkbox"/> Omit Wheelie Bar .....	\$ STD
	<input type="checkbox"/> Bolt on Single Wheelie Bar .....	\$ 200
	<input type="checkbox"/> Dual Welded Wheelie Bars .....	\$ 300
<b>FRAME OPTION</b>	<input type="checkbox"/> STD .....	\$ STD
	 <input type="checkbox"/> Offensive Wings .....	\$ 160
	 <input type="checkbox"/> Basketball Roller .....	\$ 72

**B** FRAME MEASUREMENTS 2/2

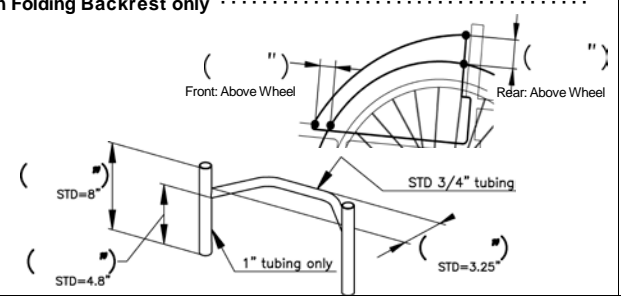
<b>5. BACKREST HEIGHT</b> <small>* Rigidizer bar 3.25" deep std.</small>	<input type="checkbox"/> 8" <input type="checkbox"/> 9" <input type="checkbox"/> 10" <input type="checkbox"/> 11" <input type="checkbox"/> 12" <input type="checkbox"/> 13" <input type="checkbox"/> 14" <input type="checkbox"/> 15" <input type="checkbox"/> 16" <input type="checkbox"/> 17" <input type="checkbox"/> 18"	\$ STD
<b>TYPE</b>	<input type="checkbox"/> Locking mechanism with adjust. height & angle .....	\$ STD
	<input type="checkbox"/> Double Locking mechanism with adjust. height & angle .....	\$ 40
	<input type="checkbox"/> Folding with adjust. height & angle .....	\$ NCO
	<input type="checkbox"/> Custom Backrest - (ie: double rigidizer bars, custom depth, custom height, etc)	\$ 200
<b>CUSTOM</b>	<input type="checkbox"/> Welded Backrest Angle Set at (                    ") to the ground *Non Folding Backrest only ·· <input type="checkbox"/> Welded Side Guards *Non Folding Backrest only .....	\$ 518
		\$ 200
<b>6. BACKREST ANGLE</b>	Set at (                    °) to the ground *STD 90° -	\$ STD
<b>7. FRONT SEAT HEIGHT</b>	<input type="checkbox"/> 15.5" <input type="checkbox"/> 16.0" <input type="checkbox"/> 16.5" <input type="checkbox"/> 17.0" <input type="checkbox"/> 17.5" <input type="checkbox"/> 18.0" <input type="checkbox"/> 18.5" <input type="checkbox"/> 19.0" <input type="checkbox"/> 19.5" <input type="checkbox"/> 20.0" <input type="checkbox"/> 20.5" <input type="checkbox"/> 20 7/8"	\$ STD
<b>8. REAR SEAT HEIGHT</b>	<input type="checkbox"/> 13.5" *24" Wheels only <input type="checkbox"/> 14.0" *24",25" Wheels only <input type="checkbox"/> 14.5" <input type="checkbox"/> 15.0" <input type="checkbox"/> 15.5" <input type="checkbox"/> 16.0" <input type="checkbox"/> 16.5" <input type="checkbox"/> 17.0" <input type="checkbox"/> 17.5" <input type="checkbox"/> 18.0" <input type="checkbox"/> 18.5" <input type="checkbox"/> 19.0" <input type="checkbox"/> 19.5" <input type="checkbox"/> 20.0" <input type="checkbox"/> 20 7/8"	\$ STD
<b>9. CENTER OF GRAVITY</b>	<input type="checkbox"/> 1.0" <input type="checkbox"/> 1.5" <input type="checkbox"/> 2.0" <input type="checkbox"/> 2.5" <input type="checkbox"/> 3.0" <input type="checkbox"/> 3.5"    .....	\$ STD
<b>10. CAMBER ANGLE</b>	<input type="checkbox"/> 8° <input type="checkbox"/> 10° <input type="checkbox"/> 12° <input type="checkbox"/> 14° <input type="checkbox"/> 16° <input type="checkbox"/> 18° <input type="checkbox"/> 20°    .....	\$ STD
<b>11. FRONT OF SEAT SLING TO FRONT OF FOOTREST</b>	(                    ")	
<b>12. INSIDE WHEEL CLEARANCE</b>	<input type="checkbox"/> 3/4 <input type="checkbox"/> 1" <input type="checkbox"/> 1 1/4" <input type="checkbox"/> 1 1/2" <input type="checkbox"/> 1 3/4" <input type="checkbox"/> 2"	\$ STD
<b>NOTE</b> Hammer is a custom made wheelchair. If you would like to customize your Hammer beyond what is available on this order form, Please submit your request here. Colours will determine as to whether this request can be accomplished while maintaining the safety and integrity of the wheelchair. If it can be accomplished the quote will reflect any and all custom charges, thank you.		





FABRIC CHOICE SHEET

1. Camouflage Girls

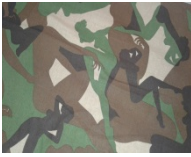

2. Purple Zebra



3. Silver Grey Snake



5. Laughing Skulls



6. Purple Snake



7. Sweetheart Pinup Girls



9. Blue Flames

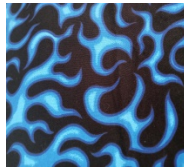

10. Artic Camo



11. Furry Friends



12. Supercars



13. Urban Camo

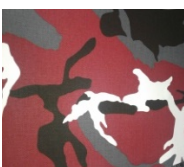

14. Superbikes



15. Sizzle Flames



16. Hot Rod Flames



17. Skulls w/ Attitude



18. Sweet Pink

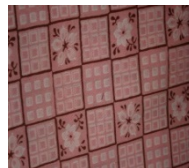

19. Heart and Soul



20. Home Run

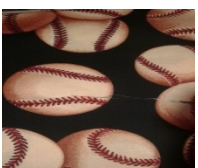

21. Fuzzy Giraffe

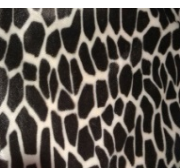

22. Cheetah



23. Paperweight Cobalt



24. Zig Zag Dots



25. Smokey Tribal Flames

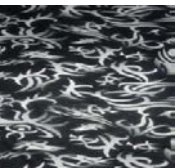

26. Rose and Rebellion



27. Tattoo Adventure(Cream

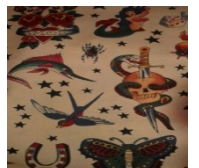

28. Red Tribal Flames

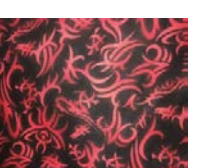

29. Tattoo Adventure(Black)

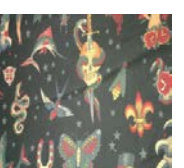

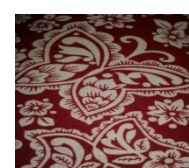

30. Butterfly Bandana

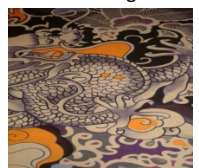

31. Tatsu Dragon



**E WHEELS, TIRES, CASTERS, & FORKS**

WHEELS												
<b>Wire Wheels</b>	<input type="checkbox"/> 24" (540) <input type="checkbox"/> 25" (559) <input type="checkbox"/> 26" (590)		\$ NCO \$ NCO \$ NCO									
<b>Spinerogy Sport Spox 24 Spoke</b> 	<input type="checkbox"/> 24" (540) <input type="checkbox"/> 25" (559) <input type="checkbox"/> 26" (590) <input type="checkbox"/> 27" (700C)    . . . . .											
	Spoke Color <input type="checkbox"/> Black With Silver Hub <input type="checkbox"/> Red With Black Hub <input type="checkbox"/> Yellow With Black Hub <input type="checkbox"/> Blue With Black Hub <input type="checkbox"/> White With Black Hub    . . . . .		\$ 1,166									
	<input type="checkbox"/> Custom Color Spoke Pattern <table border="1" style="display: inline-table; vertical-align: middle;"> <tr> <td></td> <td>Left Wheel</td> <td>Right Wheel</td> </tr> <tr> <td>Spokes Color</td> <td>Inside</td> <td>Outside</td> </tr> <tr> <td>Hub Color</td> <td><input type="checkbox"/> Black/<input type="checkbox"/> Silver</td> <td><input type="checkbox"/> Black/<input type="checkbox"/> Silver</td> </tr> </table>		Left Wheel	Right Wheel	Spokes Color	Inside	Outside	Hub Color	<input type="checkbox"/> Black/ <input type="checkbox"/> Silver	<input type="checkbox"/> Black/ <input type="checkbox"/> Silver		\$ 1,276
		Left Wheel	Right Wheel									
Spokes Color	Inside	Outside										
Hub Color	<input type="checkbox"/> Black/ <input type="checkbox"/> Silver	<input type="checkbox"/> Black/ <input type="checkbox"/> Silver										
<b>Spinerogy Sport Lite Extreme "SLX" 24 Spoke</b> 	<input type="checkbox"/> 18 Spokes <input type="checkbox"/> 24 Spokes <input type="checkbox"/> 24" (540) <input type="checkbox"/> 25" (559) <input type="checkbox"/> 26" (590) <input type="checkbox"/> 27" (700C)											
	Spoke Color <input type="checkbox"/> Black With Silver Hub <input type="checkbox"/> Red With Black Hub <input type="checkbox"/> Yellow With Black Hub <input type="checkbox"/> Blue With Black Hub    . . . . . <input type="checkbox"/> White With Black Hub <input type="checkbox"/> Neon Green With Black Hub <input type="checkbox"/> Pink With Black Hub <input type="checkbox"/> Orange With Black Hub <input type="checkbox"/> Purple With Black Hub		\$ 1,166									
	<input type="checkbox"/> Custom Color Spoke Pattern <table border="1" style="display: inline-table; vertical-align: middle;"> <tr> <td></td> <td>Left Wheel</td> <td>Right Wheel</td> </tr> <tr> <td>Spokes Color</td> <td>Inside</td> <td>Outside</td> </tr> <tr> <td>Hub Color</td> <td><input type="checkbox"/> Black/<input type="checkbox"/> Silver</td> <td><input type="checkbox"/> Black/<input type="checkbox"/> Silver</td> </tr> </table>		Left Wheel	Right Wheel	Spokes Color	Inside	Outside	Hub Color	<input type="checkbox"/> Black/ <input type="checkbox"/> Silver	<input type="checkbox"/> Black/ <input type="checkbox"/> Silver		\$ 1,276
		Left Wheel	Right Wheel									
Spokes Color	Inside	Outside										
Hub Color	<input type="checkbox"/> Black/ <input type="checkbox"/> Silver	<input type="checkbox"/> Black/ <input type="checkbox"/> Silver										
<b>HANDRIMS</b>												
<b>Type</b>	<input type="checkbox"/> <b>Standard</b> For 24", 25" or 26", 700C(27") Wheel Anodized Black . . . . .		\$ STD									
	<input type="checkbox"/> <b>Vinyl Coated</b> For 24", 25", 26" Wheel . . . . .		\$ 200									
	<input type="checkbox"/> <b>Spinerogy Silver Brushed</b> For 24", 25", 26" Wheel . . . . .		\$ 176									
	<input type="checkbox"/> <b>The Q-Grip Handrims</b> : anti-slip, latex-free, r * Not available with Y-360 Billet Wheels available with		\$ 543									
<b>TAB LENGTH</b>	<input type="checkbox"/> Long Tabs ( STD inside clearance 3/4") . . . . .		\$ STD									
	<input type="checkbox"/> Short Tabs (Inside clearance 1/2") *Not available with Natural Fit Handrim with thumb grip . . . . .		\$ STD									
	<input type="checkbox"/> Short Tab (Set closest to wheel cut off excess) . . . . .		\$ 35									
<b>TIRES</b>												
<input type="checkbox"/> <b>Primo High Pressure Tire</b> <input type="checkbox"/> 24"x1", <input type="checkbox"/> 25"x1", <input type="checkbox"/> 26"x1", <input type="checkbox"/> 27" 700C    Gray Tire with black wall Only    . . . . . <b>E2211/E2212</b>			\$ STD									
<input type="checkbox"/> <b>Primo High Pressure Tire</b> <input type="checkbox"/> 24"x1", <input type="checkbox"/> 25"x1" or <input type="checkbox"/> 26"x1" <input type="checkbox"/> Blue <input type="checkbox"/> Red    . . . . . <b>E2211/E2212</b>			\$ 100									
<b>CASTERS</b>												
<b>SIZE</b>	<b>TIRE WIDTH</b>	<b>HUB COLOR</b>	<b>TIRE COLOR</b>	<b>DESCRIPTION</b>								
<input type="checkbox"/> 3"	1"	Black Hub	Black Tire Only	Polyurethane	\$ STD							
<input type="checkbox"/> 3"	1"	Plastic Black Hub	Clear Tire Only	Lighted, Polyurethane	\$ 86							
<input type="checkbox"/> 3"	1"	Red Hub	Red Tire Only	Polyurethane	\$ STD							
<input type="checkbox"/> 3"	1"	Black Hub	Clear Tire Only	Polyurethane	\$ STD							
<input type="checkbox"/> 3"	1"	Aluminum Silver Hub	Black Tire Only	Made By Frog Legs	\$ 209							
<input type="checkbox"/> 3"	1"	Aluminum Black Hub	Black Tire Only	Made By Frog Legs	\$ 209							
<input type="checkbox"/> 3"	1.5"	Aluminum Silver Hub	Black Tire Only	Soft Roll Made By Frog Legs	\$ 209							
<input type="checkbox"/> 3"	1.5"	Aluminum Black Hub	Black Tire Only	Soft Roll Made By Frog Legs	\$ 209							
<input type="checkbox"/> "	<input type="checkbox"/> 1"OR <input type="checkbox"/> 1.5"	Hub Color:	Tread Color:	Soft Roll Made By Frog Legs <b>E2222</b>	\$ CFP							
<b>FORKS</b>												
<input type="checkbox"/> <b>STD</b> Aluminum Forks    Black Only					\$ STD							



**G CHAIR OPTIONS 1 / 2**

SEAT CUSHION				
<b>SUPRACOR® WHEELCHAIR CUSHIONS</b>				
<b>Stimulite® Contoured Cushion</b> *Black Upholstery only  *Comes with Zipper Pouch <input type="checkbox"/> Extra Sensitive (\$35 up charge) <input type="checkbox"/> Sling Style Bottom (\$52 up charge) <input type="checkbox"/> Custom Size ( \$- CFP ) W(   " ) x D(   " ) <input type="checkbox"/> Extra Cover (\$120 up charge)	<input type="checkbox"/> W14"xD16" (CD1416)	.....	<b>E2603</b> \$ 707	
	<input type="checkbox"/> W16"xD16" (CD1616)	.....	<b>E2603</b> \$ 707	
	<input type="checkbox"/> W16"xD18" (CD1618)	.....	<b>E2603</b> \$ 707	
	<input type="checkbox"/> W18"xD16" (CD1816)	.....	<b>E2603</b> \$ 707	
	<input type="checkbox"/> W18"xD18" (CD1818)	.....	<b>E2603</b> \$ 707	
	<input type="checkbox"/> W18"xD20" (CD1820)	.....	<b>E2603</b> \$ 714	
	<input type="checkbox"/> W20"xD16" (CD2016)	.....	<b>E2603</b> \$ 714	
	<input type="checkbox"/> W20"xD18" (CD2018)	.....	<b>E2603</b> \$ 714	
	<input type="checkbox"/> W20"xD20" (CD2020)	.....	<b>E2603</b> \$ 734	
	<b>Stimulite® Slimline Cushion</b> *Black Upholstery only  <input type="checkbox"/> Extra Sensitive (\$35 up charge) <input type="checkbox"/> Sling Style Bottom (\$52 up charge) <input type="checkbox"/> Custom Size ( \$- CFP ) W(   " ) x D(   " ) <input type="checkbox"/> Extra Cover (\$86 up charge)	<input type="checkbox"/> W14"xD16" (SM1416)	.....	<b>E2603</b> \$ 446
<input type="checkbox"/> W16"xD16" (SM1616)		.....	<b>E2603</b> \$ 446	
<input type="checkbox"/> W16"xD18" (SM1618)		.....	<b>E2603</b> \$ 446	
<input type="checkbox"/> W18"xD18" (SM1818)		.....	<b>E2603</b> \$ 446	
<input type="checkbox"/> W18"xD20" (SM1820)		.....	<b>E2603</b> \$ 490	
<input type="checkbox"/> W20"xD16" (SM2016)		.....	<b>E2603</b> \$ 490	
<input type="checkbox"/> W20"xD18" (SM2018)		.....	<b>E2603</b> \$ 490	
<input type="checkbox"/> W20"xD20" (SM2020)		.....	<b>E2603</b> \$ 518	
<b>Stimulite® Corbee Pediatric</b> *Black Upholstery only <input type="checkbox"/> Extra Cover (\$86 up charge)	<input type="checkbox"/> W10"xD10" (PD1010)	.....	<b>E2603</b> \$ 342	
	<input type="checkbox"/> W12"xD12" (PD1212)	.....	<b>E2603</b> \$ 342	
	<input type="checkbox"/> W14"xD14" (PD1414)	.....	<b>E2603</b> \$ 342	
	<input type="checkbox"/> Extra Sensitive (\$35 up charge) <input type="checkbox"/> Sling Style Bottom (\$52 up charge) <input type="checkbox"/> Custom Size W(   " ) x D(   " ) ( \$- CFP )			
<b>ROHO WHEELCHAIR CUSHIONS</b>				
Choose Size	<input type="checkbox"/> <b>4" HIGH PROFILE® QUADTRO SELECT® CUSHION</b> *Black Upholstery		<input type="checkbox"/> Extra Cover ( \$+100 ) only	<b>E2622-2623</b> \$ 669
	<input type="checkbox"/> W12"xD12"	<input type="checkbox"/> W12"xD13"	<input type="checkbox"/> W13"xD13"	<input type="checkbox"/> W13"xD15"
	<input type="checkbox"/> W15"xD16"	<input type="checkbox"/> W15"xD18"	<input type="checkbox"/> W16"xD15"	<input type="checkbox"/> W16"xD16"
	<input type="checkbox"/> W18"xD16"	<input type="checkbox"/> W18"xD18"	<input type="checkbox"/> W18"xD20"	<input type="checkbox"/> W18"xD22"
	<input type="checkbox"/> W20"xD22"	<input type="checkbox"/> W22"xD18"	<input type="checkbox"/> W22"xD20"	<input type="checkbox"/> W22"xD22"
<input type="checkbox"/> Custom Size W(   " ) x D(   " ) ( \$+CFP )				
Choose Size	<input type="checkbox"/> <b>3" MID PROFILE® QUADTRO SELECT® CUSHION</b> *Black Upholstery only		<input type="checkbox"/> Extra Cover ( \$+100 )	<b>E2622-2623</b> \$ 669
	<input type="checkbox"/> W15"xD15"	<input type="checkbox"/> W15"xD16"	<input type="checkbox"/> W16"xD16"	<input type="checkbox"/> W16"xD18"
			<input type="checkbox"/> W18"xD16"	<input type="checkbox"/> W18"xD18"
<input type="checkbox"/> Custom Size W(   " ) x D(   " ) ( \$+CFP )				
Choose Size	<input type="checkbox"/> <b>2" LOW PROFILE® QUADTRO SELECT® CUSHION</b> *Black Upholstery only		<input type="checkbox"/> Extra Cover ( \$+100 )	<b>E2622-2623</b> \$ 669
	<input type="checkbox"/> W12"xD12"	<input type="checkbox"/> W12"xD13"	<input type="checkbox"/> W13"xD13"	<input type="checkbox"/> W13"xD15"
	<input type="checkbox"/> W15"xD16"	<input type="checkbox"/> W15"xD18"	<input type="checkbox"/> W16"xD15"	<input type="checkbox"/> W16"xD16"
	<input type="checkbox"/> W18"xD16"	<input type="checkbox"/> W18"xD18"	<input type="checkbox"/> W18"xD20"	<input type="checkbox"/> W20"xD16"
			<input type="checkbox"/> W20"xD18"	<input type="checkbox"/> W20"xD20"
<input type="checkbox"/> Custom Size W(   " ) x D(   " ) ( \$+CFP )				
<b>THE CURVE CUSHION</b> *Black Upholstery only <input type="checkbox"/> Extra Cover ( \$+ 46	<input type="checkbox"/> W10"xD10"	<input type="checkbox"/> W10"xD11"	<input type="checkbox"/> W10"xD11"	<input type="checkbox"/> W10"xD12"
	<input type="checkbox"/> W12"xD13"	<input type="checkbox"/> W12"xD14"	<input type="checkbox"/> W13"xD11"	<input type="checkbox"/> W13"xD12"
	<input type="checkbox"/> W14"xD14"	<input type="checkbox"/> W14"xD15"	<input type="checkbox"/> W14"xD16"	<input type="checkbox"/> W15"xD14"
	<input type="checkbox"/> W16"xD14"	<input type="checkbox"/> W16"xD15"	<input type="checkbox"/> W16"xD16"	<input type="checkbox"/> W16"xD17"
	<input type="checkbox"/> W17"xD17"	<input type="checkbox"/> W17"xD18"	<input type="checkbox"/> W18"xD16"	<input type="checkbox"/> W18"xD17"
		<input type="checkbox"/> W11"xD12"	<input type="checkbox"/> W12"xD12"	
		<input type="checkbox"/> W13"xD13"	<input type="checkbox"/> W13"xD14"	
		<input type="checkbox"/> W15"xD15"	<input type="checkbox"/> W15"xD16"	
		<input type="checkbox"/> W16"xD18"	<input type="checkbox"/> W17"xD16"	



**G CHAIR OPTIONS 2 / 3**

SEAT CUSHION				
<b>Exgel Kaji Cushion</b>				
<b>For Comfortable Sitting To Prevent Pressure Sores</b>				
<input type="checkbox"/> <b>Owl Regular(1.6" Thick)</b> Incontinence Cover Only	<input type="checkbox"/> W14"xD16" <input type="checkbox"/> W15"xD16" <input type="checkbox"/> W16"xD16" <input type="checkbox"/> W18"xD16"	..... ..... ..... ..... * No Custom Sizes	<input type="checkbox"/> <b>Extra Cover \$104</b>	E2603 \$ 362 E2603 \$ 362 E2603 \$ 362 E2603 \$ 408
<input type="checkbox"/> <b>Owl High(3.1" Thick)</b> Incontinence Cover Only	<input type="checkbox"/> W14"xD16" <input type="checkbox"/> W15"xD16" <input type="checkbox"/> W16"xD16" <input type="checkbox"/> W18"xD16" <input type="checkbox"/> W18"xD18"	..... ..... ..... ..... ..... * No Custom Sizes	<input type="checkbox"/> <b>Extra Cover \$104</b>	E2603 \$ 437 E2603 \$ 437 E2603 \$ 437 E2603 \$ 495 E2603 \$ 495
<input type="checkbox"/> <b>Owl Contour(3.0" Thick)</b> Incontinence Cover Only	<input type="checkbox"/> W14"xD16" <input type="checkbox"/> W15"xD16" <input type="checkbox"/> W16"xD16" <input type="checkbox"/> W18"xD16"	..... ..... ..... .....	<input type="checkbox"/> <b>Extra Cover \$104</b>	E2603 \$ 454 E2603 \$ 454 E2603 \$ 454 E2603 \$ 495
<input type="checkbox"/> <b>Owl Deep Contour(4.3" Thick)</b>		* No Custom Sizes- Incontinence Cover Only		
<input type="checkbox"/> W14"xD16" \$518 <input type="checkbox"/> W15"xD16" \$518 <input type="checkbox"/> W16"xD16" \$518 <input type="checkbox"/> W18"xD16" \$558		<input type="checkbox"/> <b>Extra Cover \$104</b>		
<input type="checkbox"/> <b>Standard Regular(1.4" Thick)</b> Easy to Use Flat Style (superior pressure redistribution)		<b>For Pressure</b>		E2622-2623
<input type="checkbox"/> W12" x D12" \$368 <input type="checkbox"/> W13" x D13" \$368 <input type="checkbox"/> W14" x D14" \$368 <input type="checkbox"/> W14" x D16" \$368 <input type="checkbox"/> W16" x D16" \$368 <input type="checkbox"/> W16" x D17" \$368 <input type="checkbox"/> W17" x D16" \$368 <input type="checkbox"/> W17" x D17" \$368 <input type="checkbox"/> W18" x D16" \$391 <input type="checkbox"/> W18" x D18" \$391 <input type="checkbox"/> W18" x D19" \$440 <input type="checkbox"/> W18" x D20" \$440 <input type="checkbox"/> W19" x D19" \$440		<input type="checkbox"/> <b>Extra Cover \$104</b> * No Custom Sizes- Incontinence Cover Only		
<input type="checkbox"/> <b>Standard High(2.6" Thick)</b> Incontinence Cover Only		.....		E2622
*Black Upholstery only				
<input type="checkbox"/> W12" x D12" \$383 <input type="checkbox"/> W13" x D13" \$ 383 <input type="checkbox"/> W14" x D14" \$383 <input type="checkbox"/> W14" x D16" \$ 383 <input type="checkbox"/> W16" x D16" \$383 <input type="checkbox"/> W16" x D17" \$383 <input type="checkbox"/> W17" x D16" \$383 <input type="checkbox"/> W17" x D17" \$383 <input type="checkbox"/> W18" x D16" \$460 <input type="checkbox"/> W18" x D18" \$460 <input type="checkbox"/> W18" x D19" \$512 <input type="checkbox"/> W18" x D20" \$512 <input type="checkbox"/> W19" x D19" \$512 <input type="checkbox"/> W18" x D19" \$512		<input type="checkbox"/> <b>Extra Cover \$104</b>		
<input type="checkbox"/> <b>Standard Anti-Thrust(2.6" Thick)</b> * No Custom Sizes Incontinence Cover Only	<input type="checkbox"/> W16 x D16 \$460 <input type="checkbox"/> W18 x D16 \$500 <input type="checkbox"/> W18 x D18 \$500	Prevents Unwanted Forward Movement of lower back and hip bone	<input type="checkbox"/> <b>Extra Cover \$104</b>	
<input type="checkbox"/> <b>Lite Regular(2.2" Thick)</b>	<input type="checkbox"/> W16" x D16" \$374 <input type="checkbox"/> W18" x D16" \$397 <input type="checkbox"/> W18" x D18" \$397	* No Custom Sizes- Incontinence Cover Only		
		<input type="checkbox"/> <b>Extra Cover \$104</b>		
<input type="checkbox"/> <b>Lite High(3.0" Thick)</b>	<input type="checkbox"/> W16" x D16" \$408 <input type="checkbox"/> W18" x D16" \$431 <input type="checkbox"/> W18" x D18" \$431	* No Custom Sizes- Incontinence Cover Only		
		<input type="checkbox"/> <b>Extra Cover \$104</b>		